

FFOB-340
Stainless Steel lid with
14mm Rebate

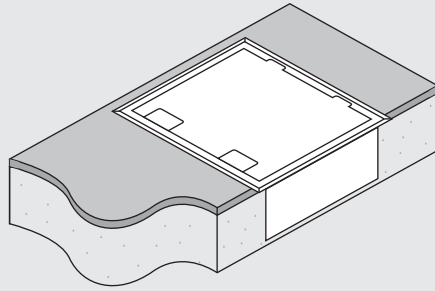

FFOB-340S
Solid Stainless Steel lid

AT A GLANCE

Capacity:	12 x Round Autoswitched
	GPOs & 2 x Clipsal 2000 Series
	Style Power/ Data/ AV Outlets
Lid Material:	Stainless Steel
Lid Size:	241 x 340mm
Box Size:	318 x 218 x 110mm
Recess Size:	338 x 238 x 120mm

This Floor Box Weighs Up To: 6.5KG's

Above View

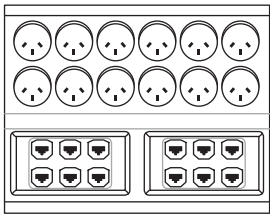

Cut-Out Side View

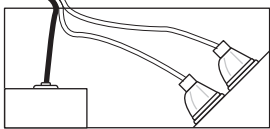

Rear Elevation

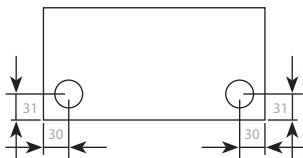

Side Elevation

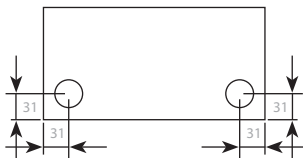

Typical Conduit Hole Location.
Size = 25mm Conduit Knockouts

Features

Hinged Lid 241 x 340mm,
screw fixes to Steel Box Body

2 x Cord Exit Flaps -
allow cords out with main
cover closed

Temporary Cover - secure to
body during concrete pour to
prevent ingress of slurry

Steel Box Body - 318 x 218 x
110mm nom. deep. Has 12 x
25mm conduit knockouts - 2
on each side of box and 4 on
the base

12 x 10Amp Round
Autoswitched GPOs
(supplied)

Outlet Bracket to Suit 2 x
Clipsal 2000 Series Style
Power/ Data /AV Outlets

Block-out in concrete slab
338 x 238 x 120mm nom.
Cut-out in raised floor
320 x 220mm nom.

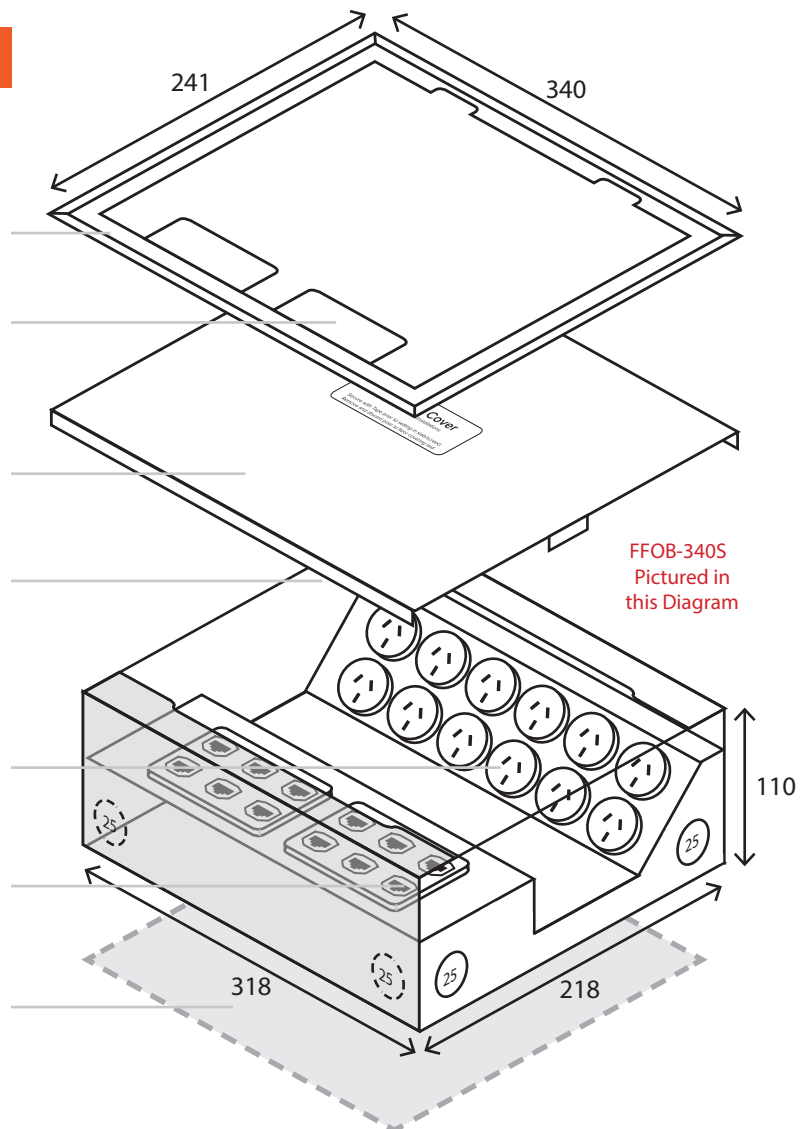

Data outlets are not included. All Dimensions quoted are nominal only. Drawings, images and diagrams are for illustrative purposes only and are not to scale. Product details and dimensions are subject to change without notice. This product is not suitable for use in wet areas, is intended for use with fixed wiring only and must be installed by a licensed electrical mechanic in accordance with AS3000, SAA Wiring Rules and A.C.A Requirements

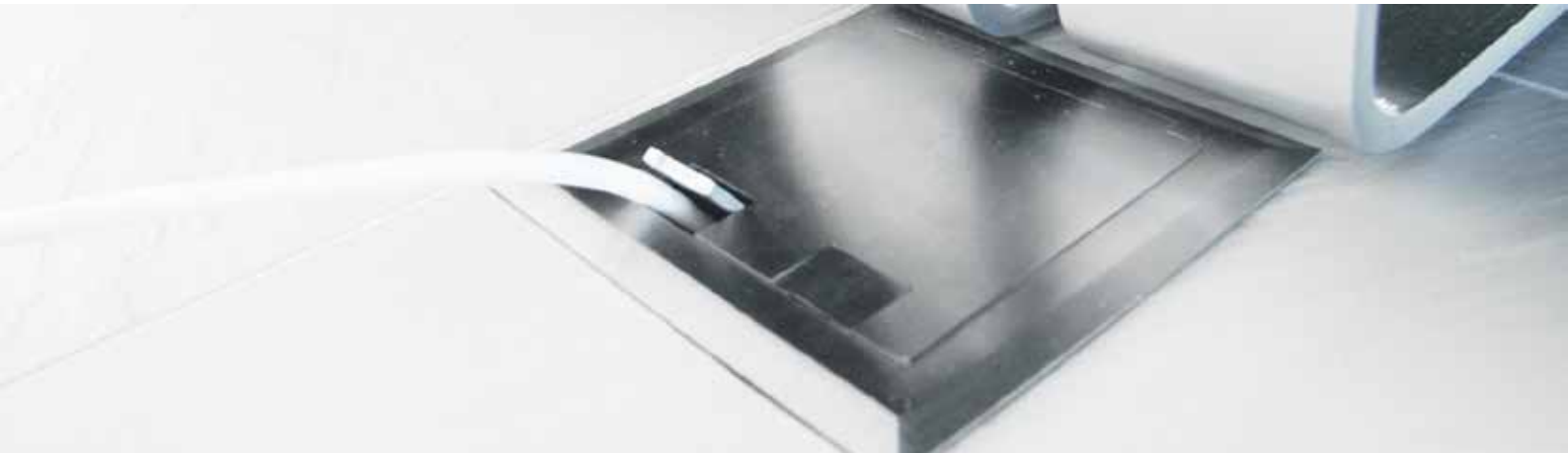

Step 1: Prepare Area for Installation

Option 1. Slab/ Screed Installation

- Secure Steel Box Body housing (318x218x110mm) to structural slab (recommended) or within preformed recess/blockout (338x238x120mm). Ensure Box Body is positioned to finish flush and level with final slab surface and is secured to prevent 'dipping' or 'floating' within screed
- Positioning and securing the Box Body accurately will prevent operation/installation problems at later stages
- Connect conduits to Steel Box Body at desired location(s) and cover opening in box body using the Temporary Cover to prevent screed entering the box. Cover screw heads using duct tape, to allow screw removal after screed hardens.

Important: Seal any gaps around conduit entries with sealant or duct tape prior to screeding it

Option 2. Raised/ TIMBER Floor, Desk or Counter Top

- Remove & Discard Temporary Cover. Cut aperture (316x216mm) in floor at desired location. The Floor/ Desk/ Counter is then sandwiched between Lid (above) and Steel Box Body (below).

or

- Remove & Discard Temporary Cover. The Steel Box Body may be dropped into a 320x220mm aperture and screw fixed through the sides - near the top opening - to prevent it from being lifted out. An adhesive sealant may also provide additional rigidity - apply to the area where the Steel Box Body meets the Floor/ Desk/ Counter. Do not attach Floor Box Lid until any adhesive is hardened so as to avoid contact with lid hinges.
- Optional Floating Floor brackets are available upon request.

Step 2: Floor box Lid Installation

- Remove Temporary Cover from Steel Box Body (if not done so already when installing in a raised floor, desk or counter top)
- Lay and trim floor surface (carpet, vinyl, tiles etc) to the size of the floor box steel box body for 340 & 340S
- Terminate outlets as required (as per AS3000) fixing them to the mounting bracket supplied and ensuring all metal components maintain earth continuity
- Fit hinged cover using M4 countersunk screws supplied and test the operation of the unit. Floor coverings under the hinge may interfere with operation - trim any floor coverings clear of the hinging points.

Important: The Lid hinge point should be above the power outlets to allow maximum room for the cables to exit the floorbox easily